

8'-0" X 10'-0"
STANDARD MANHOLE

One-Piece Manhole				
HEADROOM		SLAB	WALL	FLOOR
MIN.	MAX.	6"	6"	6"
3'-6"	4'-6"			

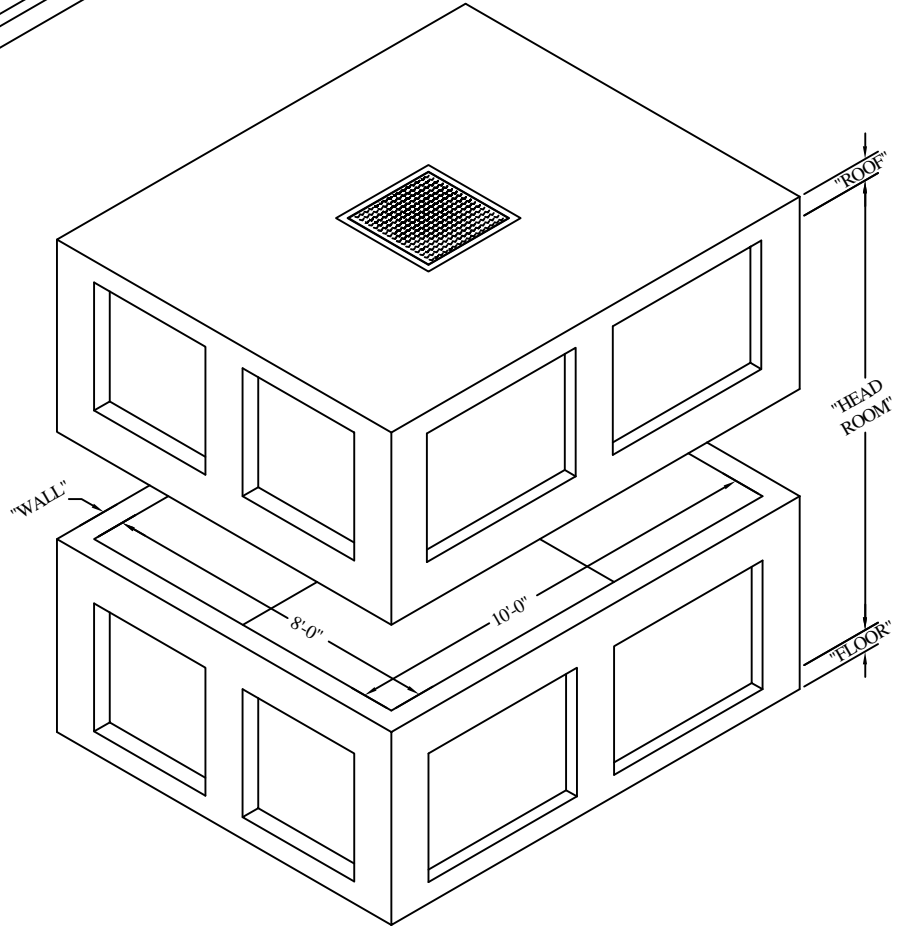
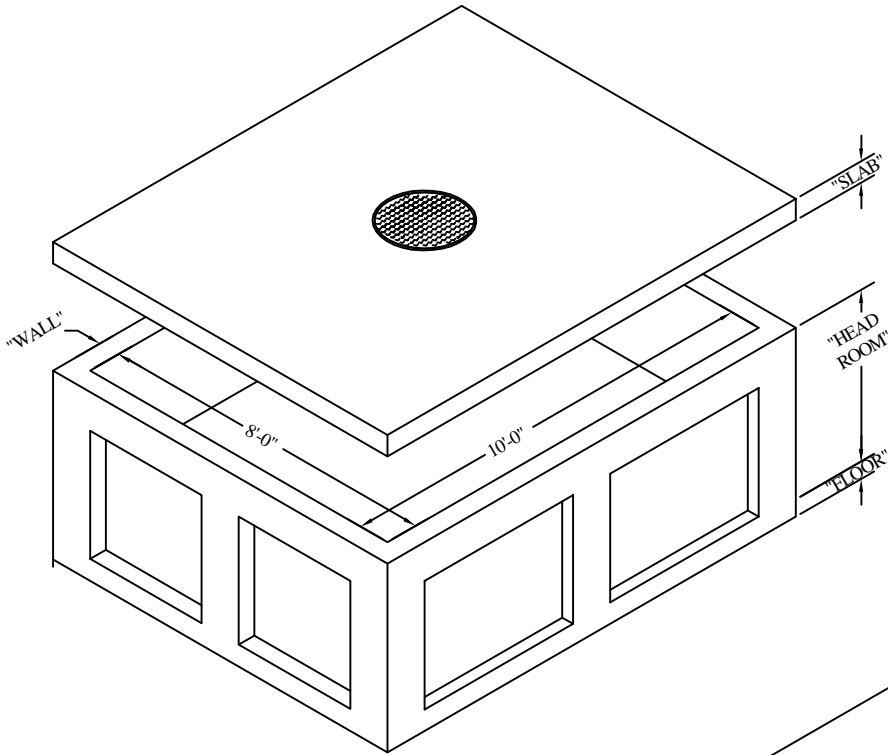

Two-Piece Manhole				
HEADROOM		ROOF	WALL	FLOOR
MIN.	MAX.	6"	6"	6"
7'-0"	9'-0"			

AC MILLER
CONCRETE PRODUCTS, INC.
WWW.ACMILLER.COM

31 E. BRIDGE ST.
SPRING CITY
PA. 19475

PHONE:
(610) 948-4600
FAX:
(610) 948-9750

RT.22 WEST
BLAIRSVILLE,
PA. 15717

PHONE:
(724) 459-5950
FAX:
(724) 459-9151

Precast Concrete Utility Vaults
8'-0" X 10'-0" Manhole
with Standard Knockout Panels

FILE NAME: 08x10 MANHOLE P1

DATE: 8/20/03

DRAWN BY: BTH

8'-0" X 10'-0"
STANDARD MANHOLE

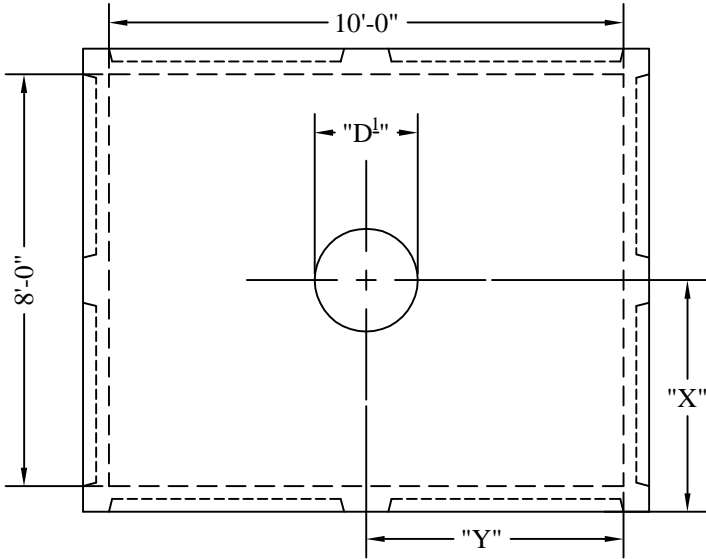

PLAN VIEW

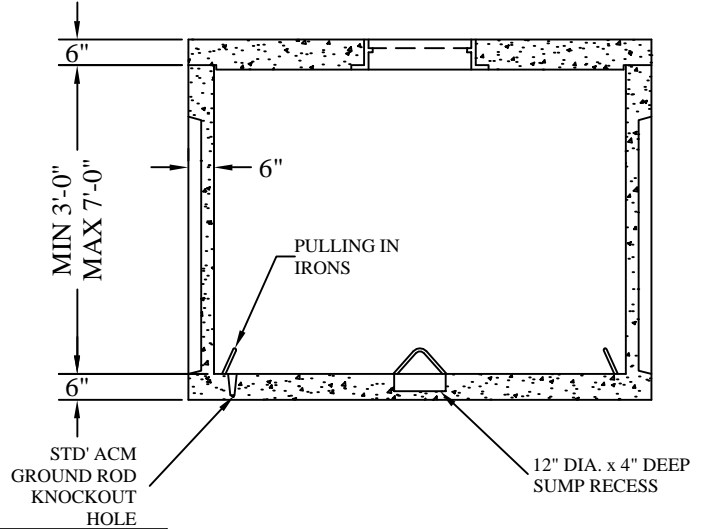

SECTION VIEW

ONE-PIECE MANHOLE

TWO-PIECE MANHOLE

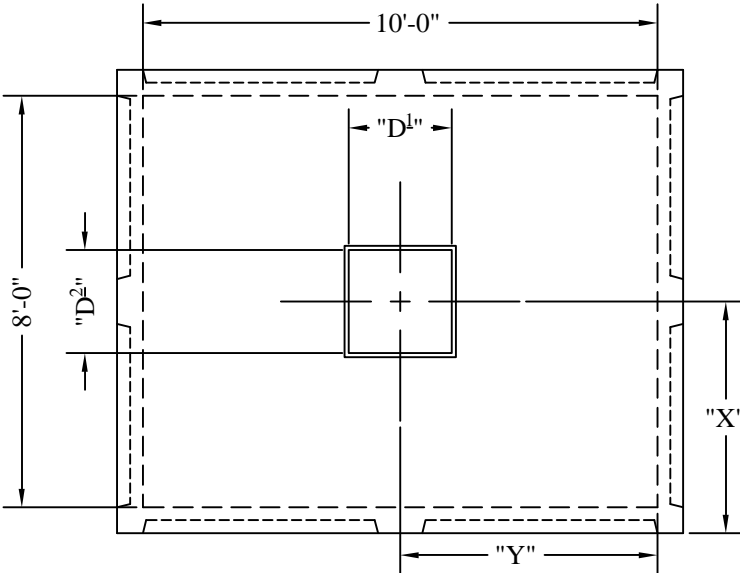

PLAN VIEW

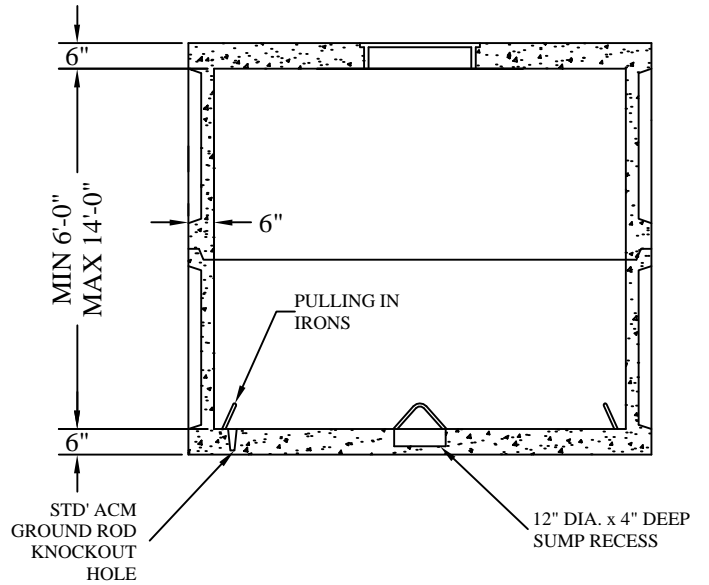

SECTION VIEW

"X" = _____

"Y" = _____

"D1" = _____

"D2" = _____

CIRCLE ALL THAT IS APPLICABLE

FRAME AND COVER, HATCH OR NONE

IF HATCH OR FRAME AND COVER:

CAST IN SLAB OR SEPERATE

* PLEASE NOTE:
ACM USES INSIDE DIMENSIONS TO
DESCRIBE VAULT SIZE.

* FOR ANY ADDITIONAL
INFORMATION PLEASE CONTACT
A.C. MILLER SALES
REPRESENTATIVE

JOB: _____
CUSTOMER: _____
DRAWING ___ OF ___

LIVE LOAD: HS-20
EARTH COVER: 0 to 2 ft.
CONCRETE: 5000 psi AT 28 DAYS
REBAR: GRADE 60, ASTM A615 SPEC'S
PRECAST CONCRETE VAULT CONFORMS TO ASTM
C890 AND C913 SPECIFICATIONS

31 E. BRIDGE ST. PHONE: (610) 948-4600
SPRING CITY FAX: (610) 948-9750
PA. 19475

RT.22 WEST PHONE: (724) 459-5950
BLAIRSVILLE, FAX: (724) 459-9151
PA. 15717

Precast Concrete Utility Vaults
8'-0" X 10'-0" Manhole
with Standard Knockout Panels

FILE NAME: 08x10 MANHOLE P2

DATE: 8/20/03

DRAWN BY: BTH